

# 4740013COMCLUK White

## 4740408COMCLUK Grapite Grey

### 5 Shelf Bookcase

**COSMO**Living  
by COSMOPOLITAN

Date of Purchase \_\_\_ / \_\_\_ / \_\_\_  
Lot Number:

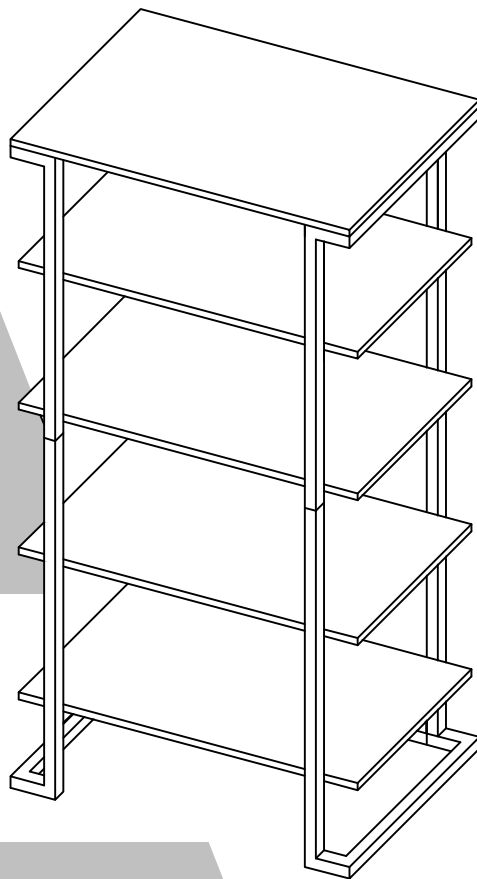

THIS INSTRUCTION BOOKLET CONTAINS **IMPORTANT** SAFETY INFORMATION. PLEASE READ AND KEEP FOR FUTURE REFERENCE.

#### **Do Not Return This Product!**

Contact our customer service team for help first.

**Call:** 01942 524100

**Email:** [cseurope@dorel.com](mailto:cseurope@dorel.com)

## **WARNING**

- Unit can tip over causing severe injury or death.
- Anchor unit to stud in wall (if instructed to).
- Do Not allow children to climb on unit.
- Put heavy items on lower shelves or drawers.

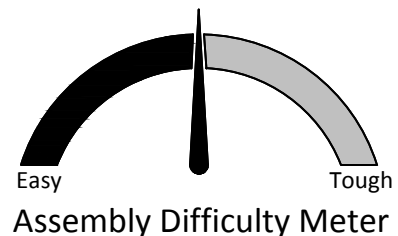

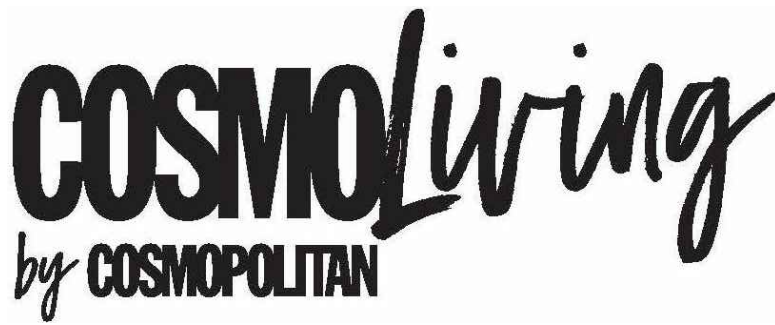

## Helpful Hints

PEOPLE NEEDED FOR ASSEMBLY: **1-2**  
ESTIMATED ASSEMBLY TIME: **1 HOUR**

- Open your item in the area you plan to keep it to avoid excessive heavy lifting.
- Identify, sort and count the parts before attempting assembly.
- Compression dowels are lightly tapped in with a hammer.
- Slides are labeled with a **R** (right) and **L** (left) for proper placement.
- Make sure to always face the point on the top of the Cam Lock towards the outer edge.
- Use all the nails provided for the back panel and spread them out equally.
- Back panel must be used to make sure your unit is sturdy.
- Do NOT use harsh chemicals or abrasive cleaners on this item.
- Never push, pull, or drag your furniture.



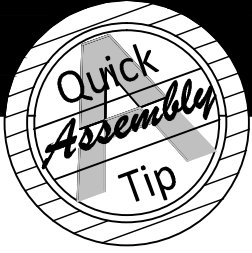

## Before You Start

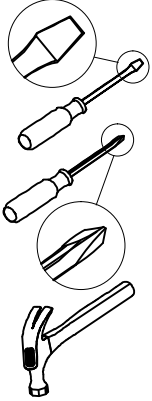

- ✓ Read through each step carefully and follow the proper order
- ✓ Separate and count all your parts and hardware
- ✓ Give yourself enough room for the assembly process
- ✓ Have the following tools: Flat Head Screwdriver, #2 Phillips Head Screwdriver and Hammer
- ✓ Caution: If using a power drill or power screwdriver for screwing, please be aware to slow down and stop when screw is tight. Failure to do so may result in stripping the screw.

# Board Identification

Not actual size

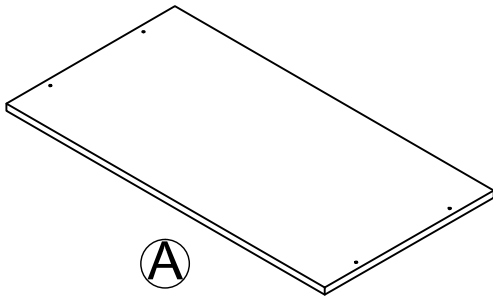

**A**  
TOP PANEL  
T4740013010KX

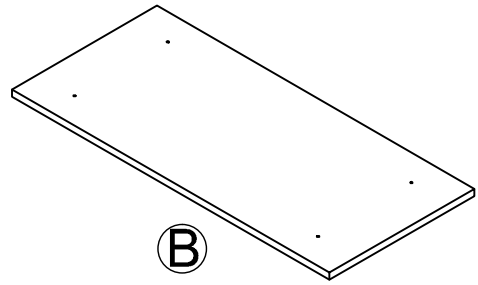

**B**  
SHELF  
T4740013020KX  
QTY:4PCS

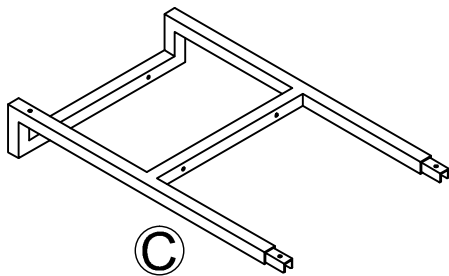

**C**  
RIGHT UPPER FRAME  
T4740013030KX

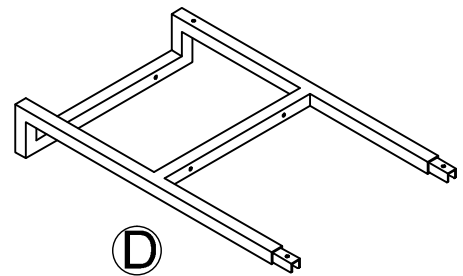

**D**  
LEFT UPPER FRAME  
T4740013040KX

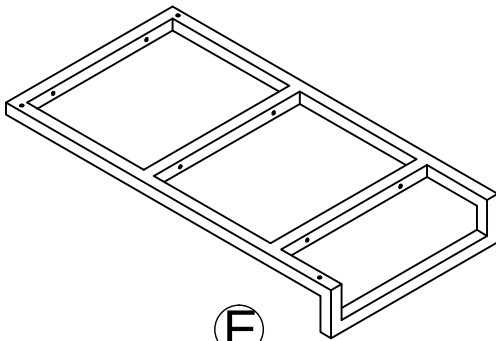

**E**  
RIGHT DOWN FRAME  
T4740013050KX

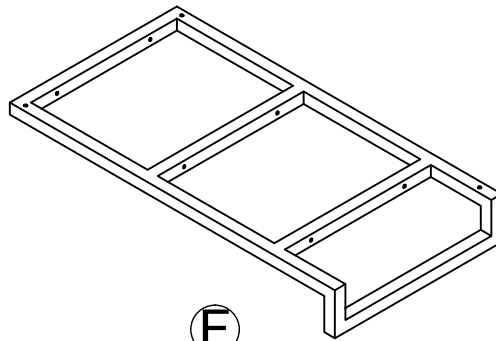

**F**  
LEFT DOWN FRAME  
T4740013060KX

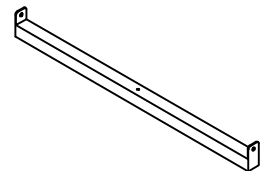

**G**  
CROSS BAR SUPPORT  
T4740013070KX  
QTY: 2 Pcs

# Board Identification

Not actual size

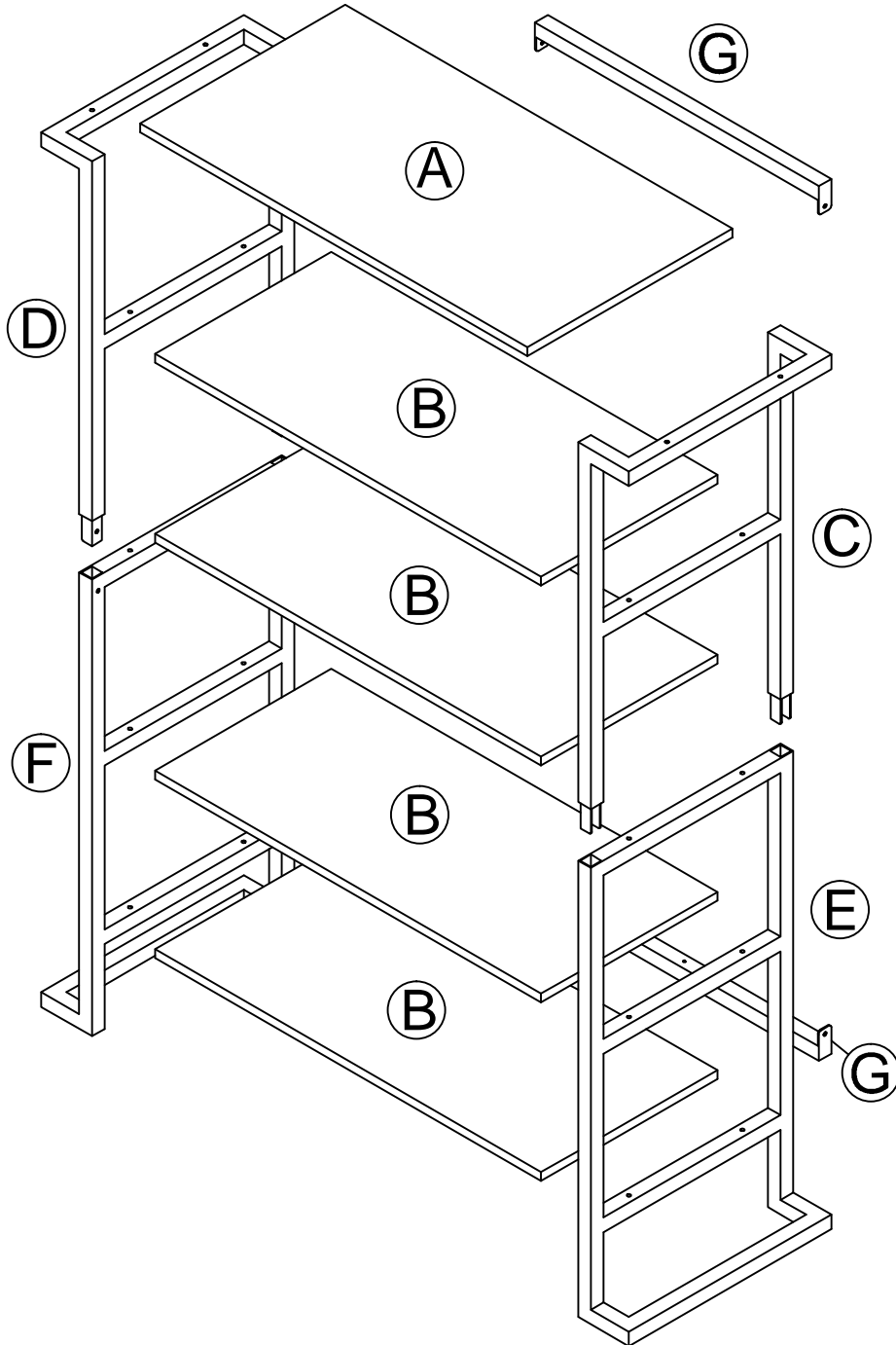

# Part List

## Actual Size

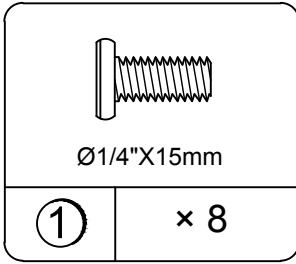

BOLT  
TKX0001

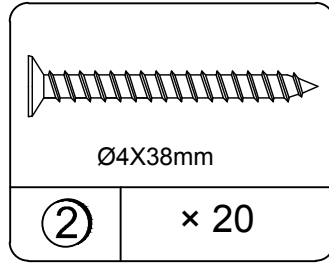

SCREW  
TKX0029

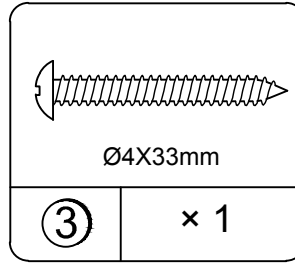

SCREW  
TKX0012

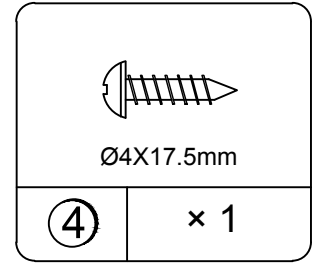

SCREW  
TKX0093

## Not Actual Size

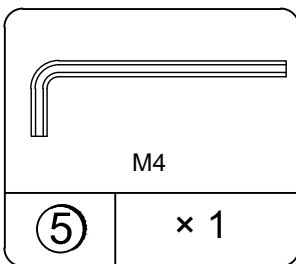

HEX KEY  
TKX0018

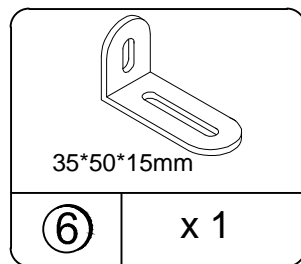

WALL BRACKET  
TKX0091

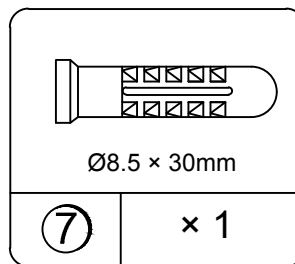

WALL ANCHOR  
TKX0092

# STEP 1

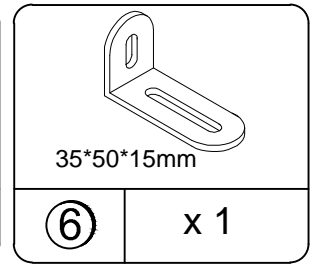
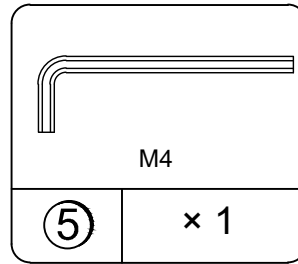
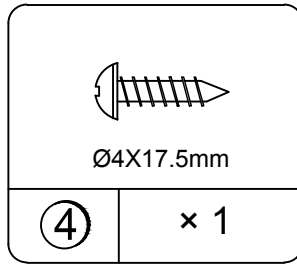
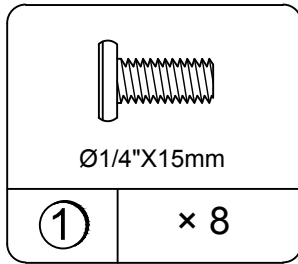
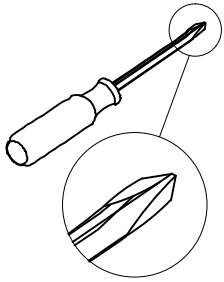

- 1.1 Attact (6) to (G) with (4) as illustrated.
- 1.2 Attact (C) & (D) to (G) with (1) as illustrated.
- 1.3 Attact (E) & (F) to (G) with (1) as illustrated.
- 1.4 Connect (C) to (E) & (D) to (F) together by (1) as illustrated.

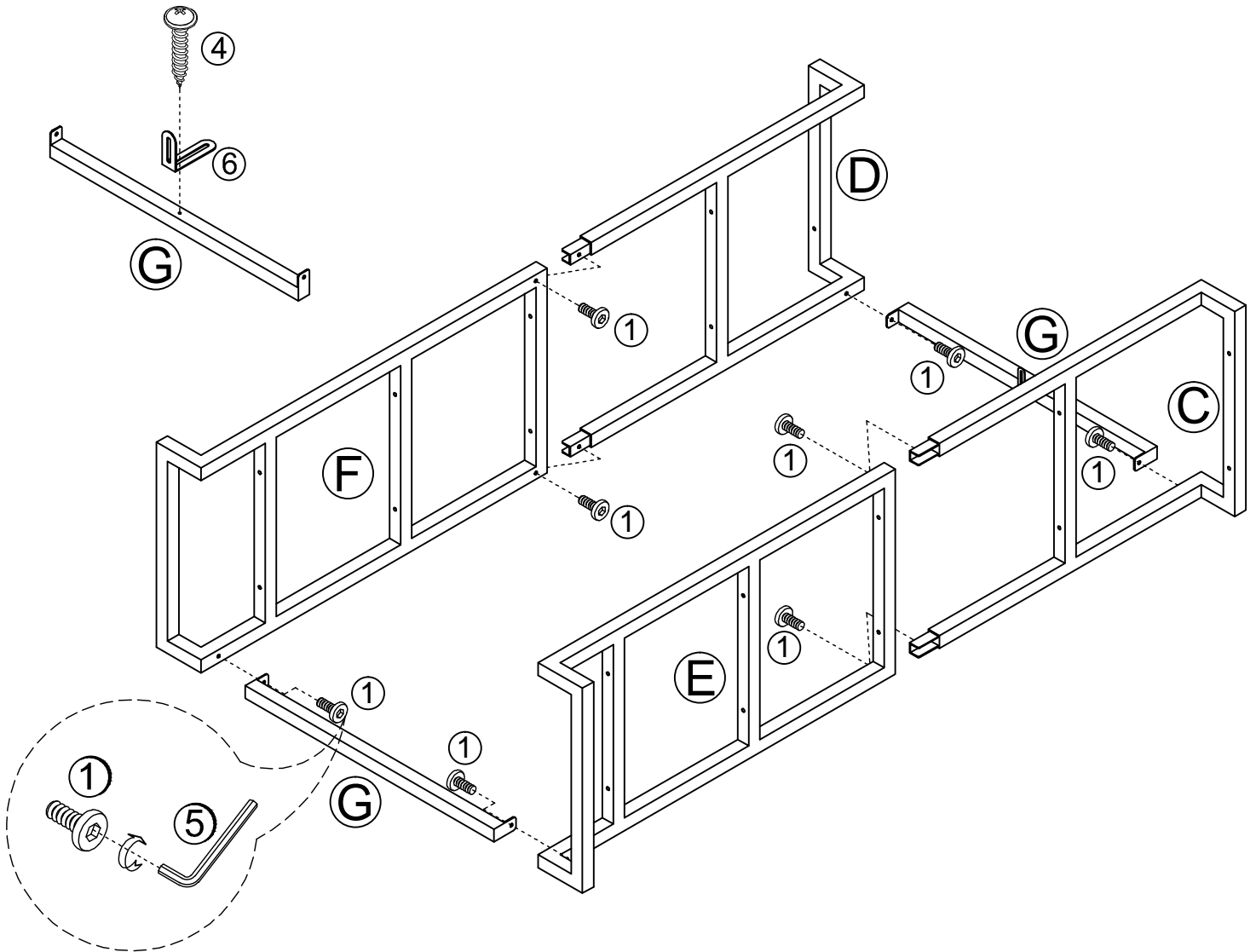

## STEP 2

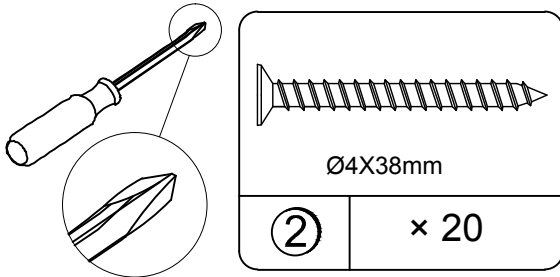

2.1 Attach (A) & (B) to metal parts with (2) as illustrated.

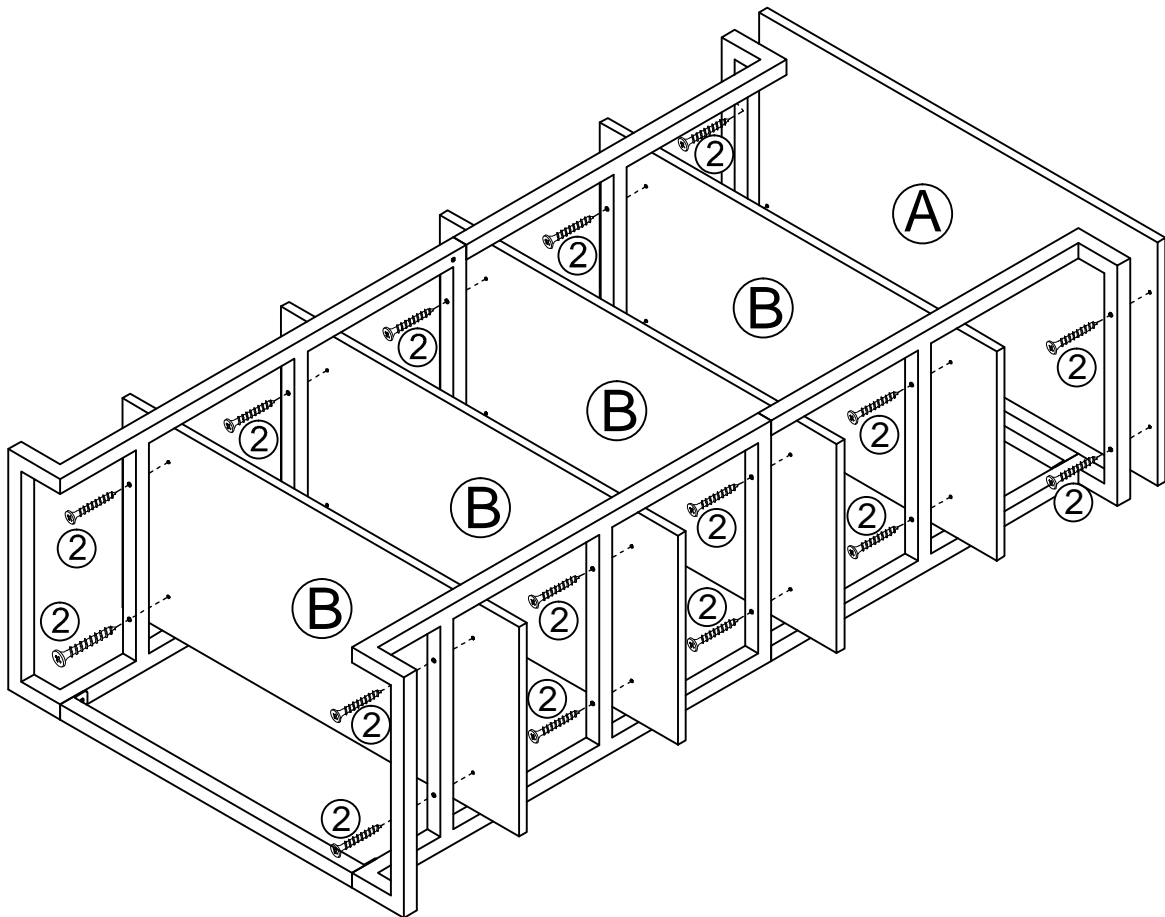



# STEP 3

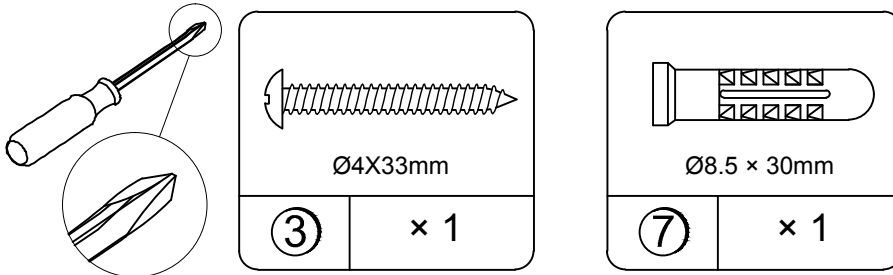

3.1 Attach (6) to wallboard with (3) & (7) as illustrated.

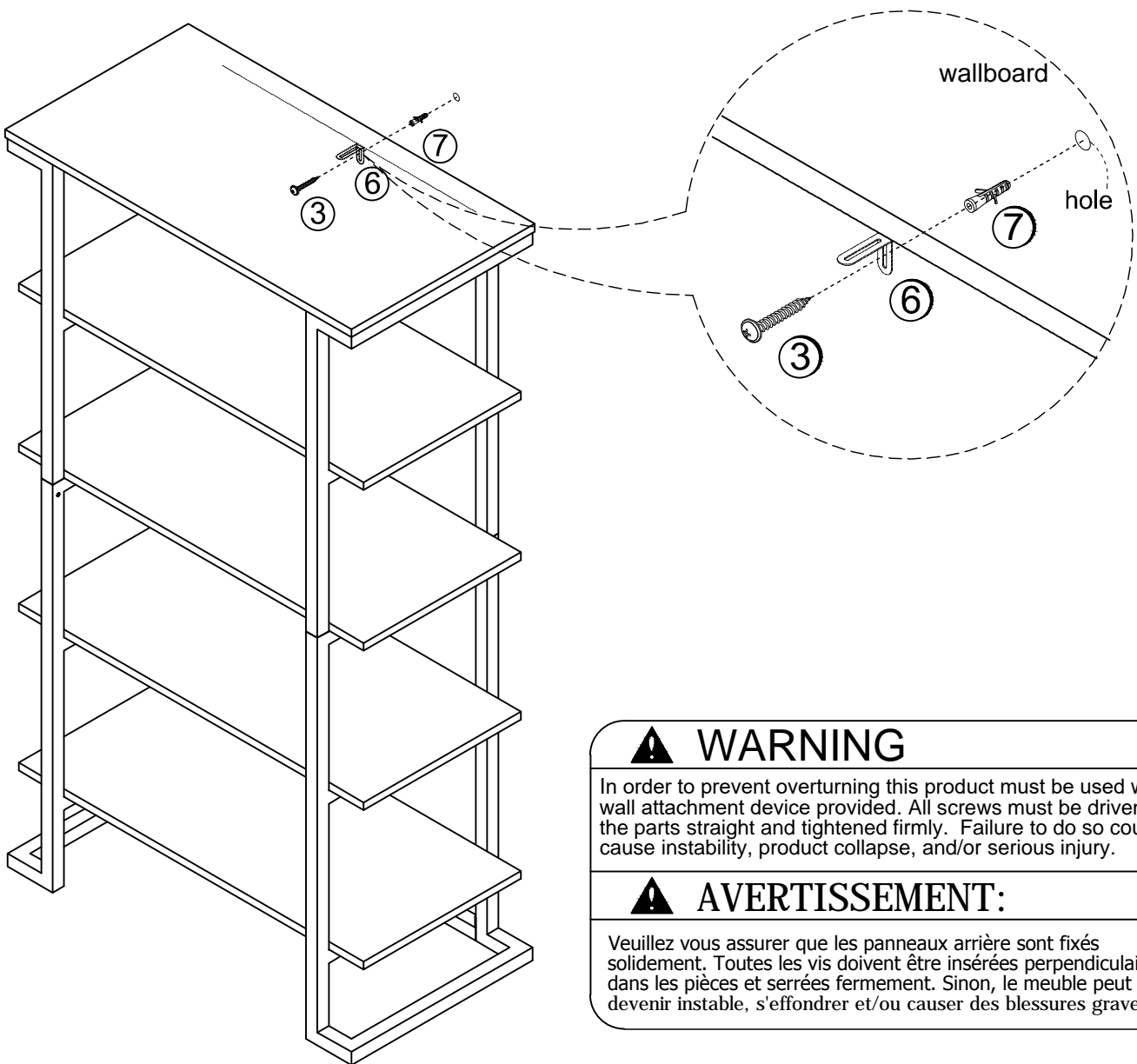

## ⚠ WARNING

In order to prevent overturning this product must be used with the wall attachment device provided. All screws must be driven into the parts straight and tightened firmly. Failure to do so could cause instability, product collapse, and/or serious injury.

## ⚠ AVERTISSEMENT:

Veillez vous assurer que les panneaux arrière sont fixés solidement. Toutes les vis doivent être insérées perpendiculairement dans les pièces et serrées fermement. Sinon, le meuble peut devenir instable, s'effondrer et/ou causer des blessures graves.

## Maximum Loads

---

This unit has been designed to support the maximum loads shown. Exceeding these load limits could cause sagging, instability, product collapse, and/or serious injury.

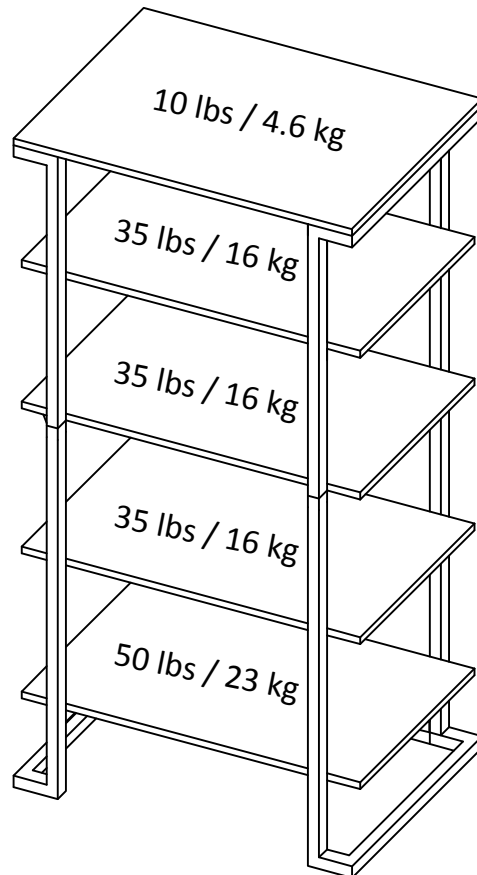

**Warning: Risk of injury to persons - do not place a television on this furniture. This furniture is not approved for use with a television.**

---