

ASSEMBLY INSTRUCTIONS

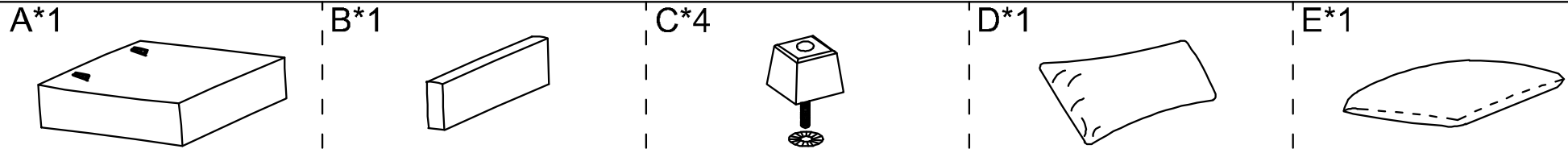

ARM CHAIR:

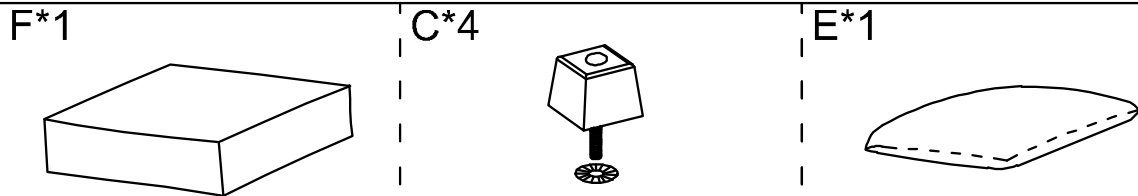
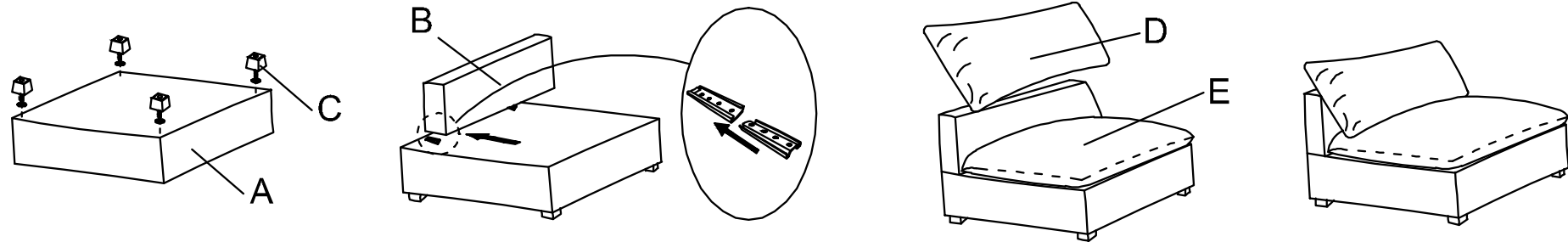

OTTOMAN:

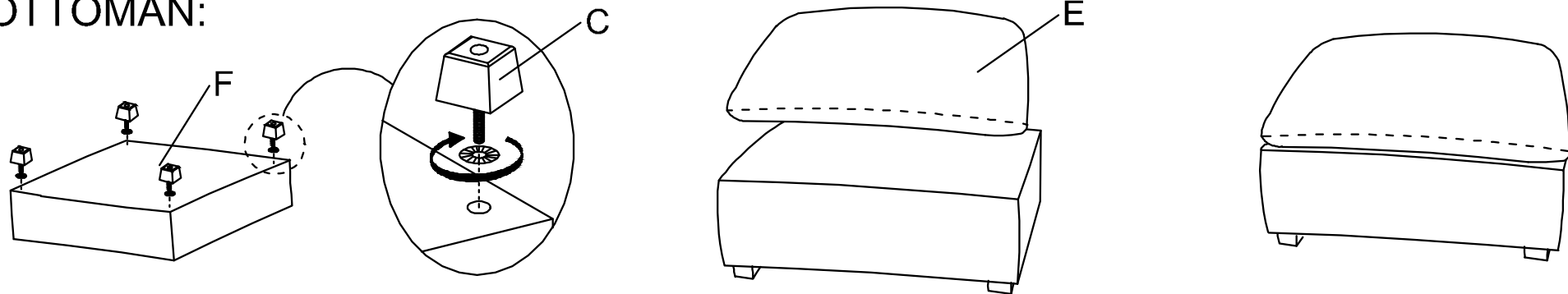

G*1

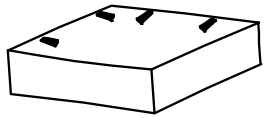

H*1

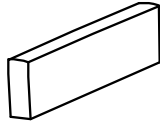

I*1

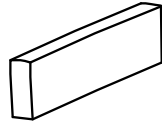

J*1

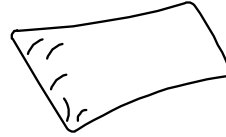

D*1

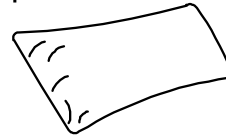

E*1



C*4

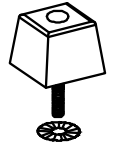

CORNER:

