

## USING YOUR SOFA BED

**FROM SOFA TO BED:** Hold the back of the sofa and tilt forward towards seat until you hear ONE click. Gently tilt the back into the bed position.

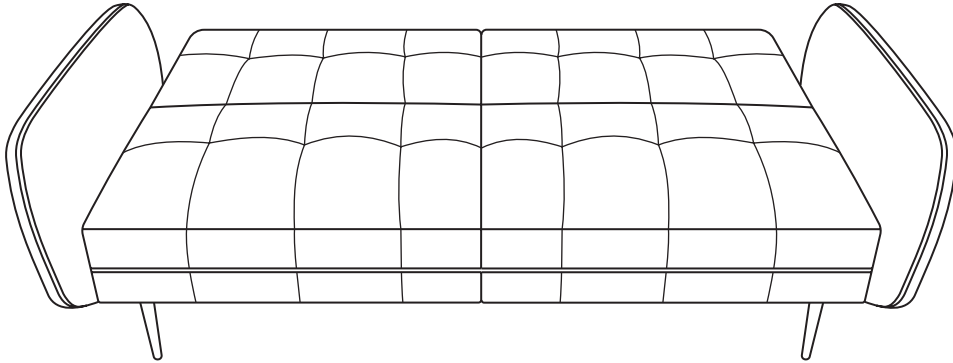

**FROM BED TO SOFA:** Lift the back until you hear ONE click to place it in a recliner position. Lift the back until you hear TWO clicks for the fully upright sofa position.

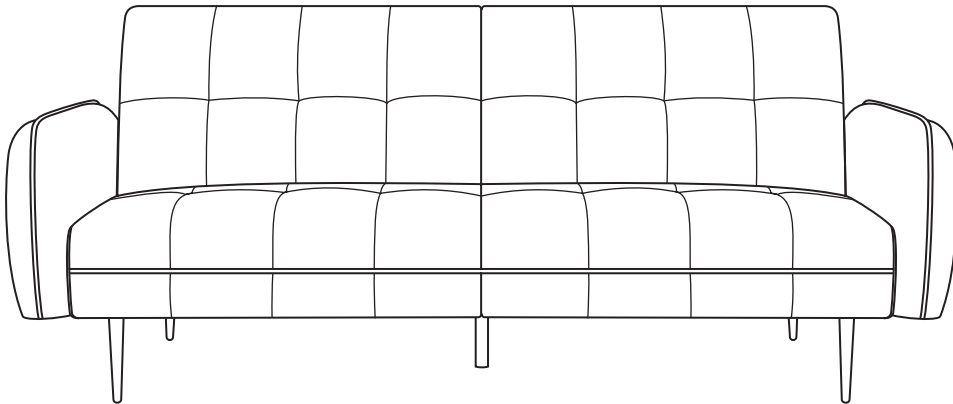

FABRIC CONTENT  
MAIN FABRIC 100% POLYESTER  
OTHER FABRIC (VISIBLE)  
NON-WOVEN FABRIC 100% POLYESTER

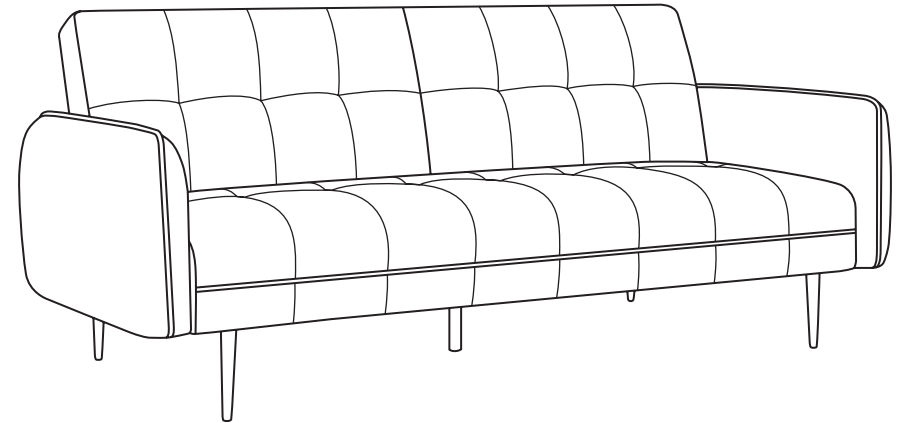

## KY093 SOFA BED

Thank you for your purchase. The following care instructions will allow you to make the most of your sofa bed; helping to prolong the look and life of it by preventing wear and damage.

### IMPORTANT INFORMATION

**PLEASE ENSURE YOU READ THIS LEAFLET BEFORE USING YOUR SOFA BED. DO NOT DISCARD OF ANY PACKAGING UNTIL YOU HAVE CHECKED THE PRODUCT THOROUGHLY.**

### CARING FOR YOUR SOFA BED

- Pre-brush fabric with a soft brush and then gently vacuum.
- Plump any accent/removable cushions regularly to prevent them becoming mis-shaped or flat.
- Use a microfibre cloth to remove dust from wooden surfaces.
- In the event of a spill or stain, use specialist upholstery cleaner or cleaning services.

### SUNLIGHT AND HEAT DAMAGE





- Avoid contact with direct sunlight. If needed, move items or change their position to avoid the same area being exposed to repeated sunlight/heat.
- Do not place your sofa bed close to fire places and/or radiators.
- Hot objects such as mugs/plates can permanently mark the fabric and wood, avoid placing these on the sofa bed.

- Do not allow children or pets to climb or jump on the sofa bed.
- Avoid contact with sharp objects such as buckles, toys and jewellery as these can easily snag, tear and/or pull the fabric.

### ENTRAPMENT WARNING

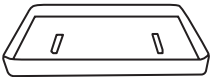
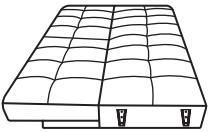
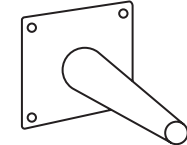
- Avoid the risk of entrapment by using the sofa bed as intended; sitting facing forward on the seat.
- Do not allow children to operate the sofa bed mechanism.

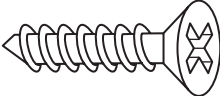
### PARTS LIST

| IMAGE   | DESCRIPTION | PART NO. | QTY |
|---|-------------|----------|-----|
|     | Arms        | A        | 2   |
|     | Base        | B        | 1   |
|    | Legs        | C        | 4   |
|  | Support Leg | D        | 1   |
|   | Screws      | E        | 16  |
|   | Screwdriver | F        | 1   |

### ASSEMBLY INSTRUCTIONS

Unpack your sofa bed and check that all the parts on the Parts List are present - these may be in a zip compartment within the base. If any are missing, please contact the retailer from whom you purchased the product.

#### STEP 1

Assemble your sofa bed on a flat and soft surface to prevent any damage. Safely position the Base (B) in a way that allows you to attach the Legs (C) and Support Leg (D), as shown below.

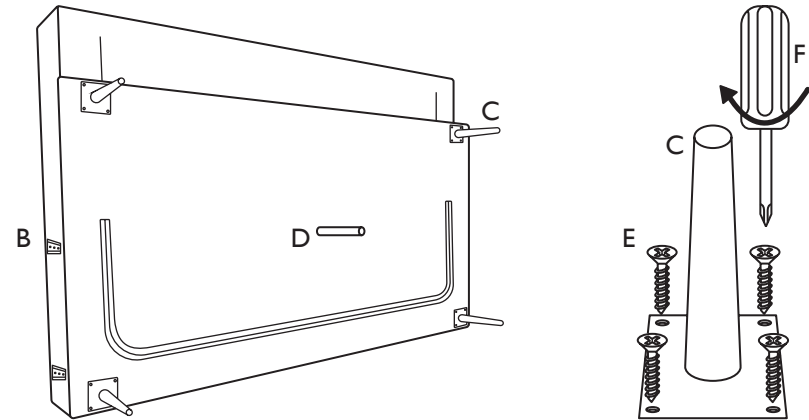

#### STEP 2

Place the base piece on its legs. Connect the Arms (A), using the metal slides, pushing down firmly.

